

frame by Lassen.

Copenhagen

by Lassen owns the rights to the designs of two of Denmark's greatest architects – Mogens Lassen (1901-1987) and Flemming Lassen (1902-1984). The Lassen brothers were extremely talented and were honoured with many awards and grants for their unique designs and iconic architecture. by lassen is a family business whose simple mission is to carry the Lassen legacy forward – because good design lives on through new generations.



FRAME

A Mogens Lassen sketch from 1943 forms the starting point for Frame, a flexible storage solution comprised of square boxes in cubic frames. Frame modules can be hung directly on the wall, connected together, stacked, or stand on their own on the floor.

Combine Frame modules into a classic shelf, a unique sculpture or something entirely new. The individual combination options are endless. Frame is manufactured in Denmark and created with attention to detail.

Frame unites functionality, quality and aesthetics. You decide the ultimate look.

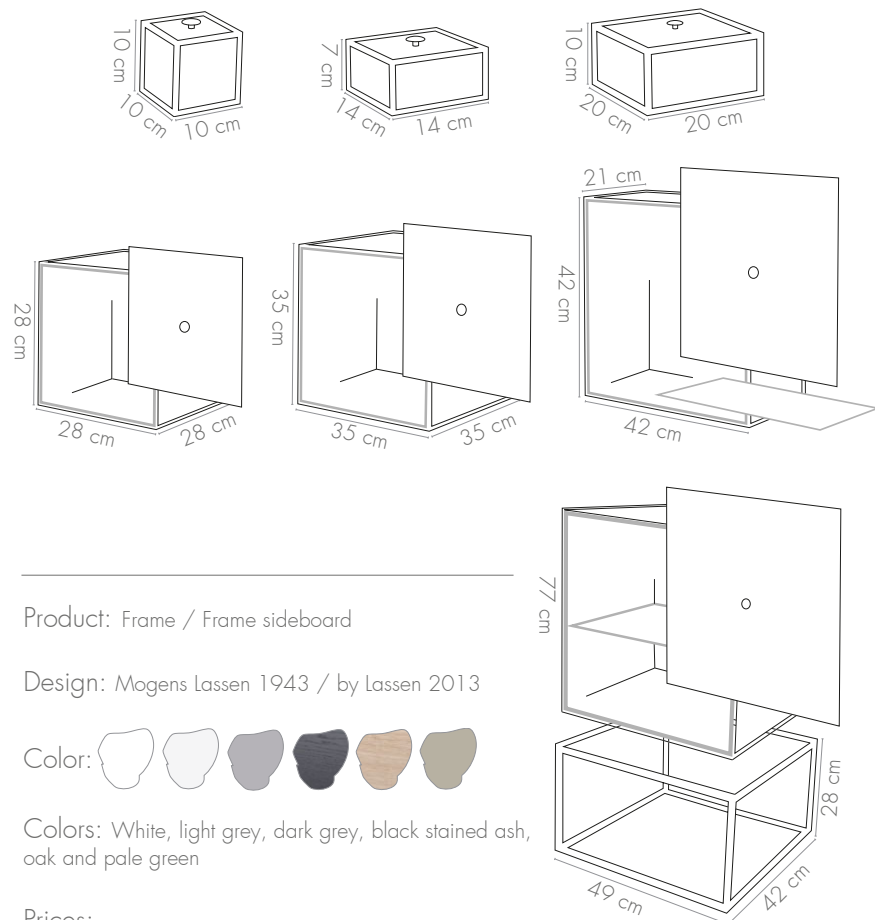

Product: Frame / Frame sideboard

Design: Mogens Lassen 1943 / by Lassen 2013

Color: 

Colors: White, light grey, dark grey, black stained ash, oak and pale green

Prices:

Frame: From 599 DKK / 79 EUR

Frame Sideboard: From 3.198 DKK / 439 EUR excl. door incl. base

Material: White, light grey, dark grey or pale green melamine, black stained ash, oak veneer / MDF

instructions

frame

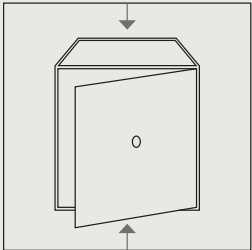

1)

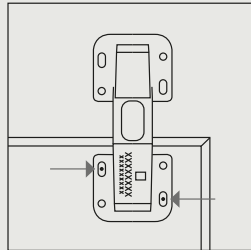

2)

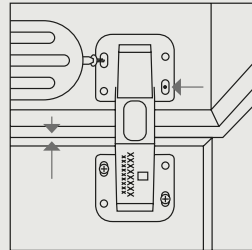

3)

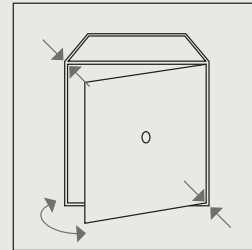

4)

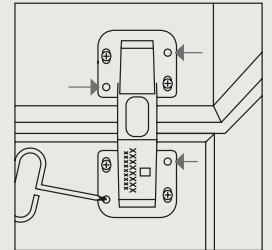

5)

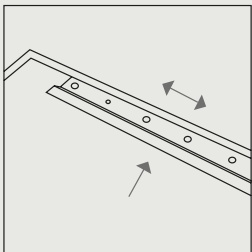

6)

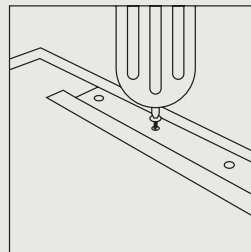

7)

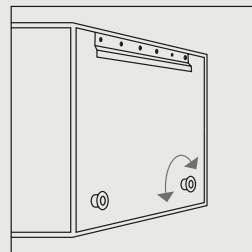

8)

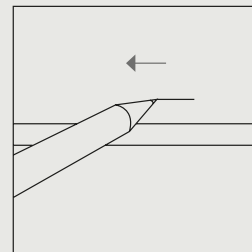

9)

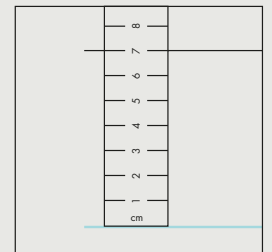

10)

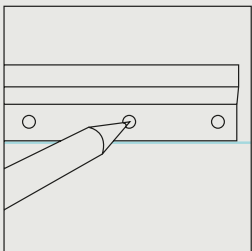

11)

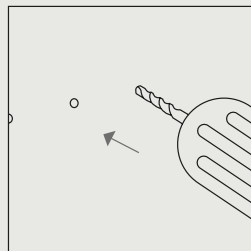

12)

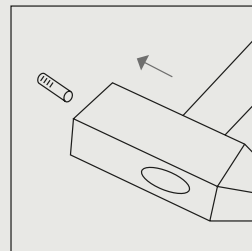

13)

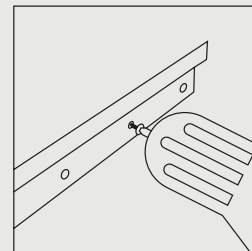

14)

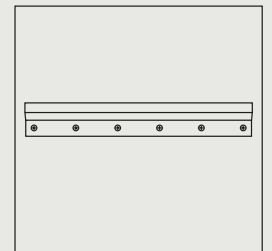

15)

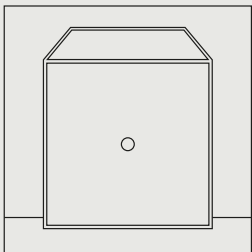

16)

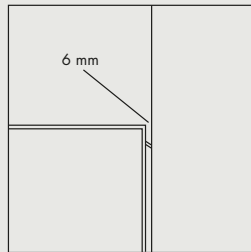

17)

instructions

frame

Tool list: drill, tape measure, spirit level, pencil, awl and the enclosed PZ-1 bits.

- 1) Define the top and bottom of Frame. If you do not wish to mount the door, go directly to Step 6.
- 2) Begin by mounting the hinges on the door using the 2 diagonal pre-punched holes. Important! The hinge part with text is for the door and the hinge part without text is for the box.
- 3) Now push the door all the way up to the edge of the box, and screw the hinge into the box using the 2 diagonal pre-punched holes.
- 4) When the hinge is secured in the pre-punched holes, test that the door doesn't bump into the edge when the door is opened and closed. If this occurs, loosen the screws slightly in the pre-punched holes in the door, then lift or lower the door and tighten the screws. Test the door again and adjust if necessary. Make sure that the door is pushed all the way up to the edge of the box when it is mounted to Frame.
- 5) When the door has been adjusted, place Frame down and open the door. Using an awl or drill, punch the final holes for the hinge and screw in the remaining screws until the hinge is fully secured.
- 6) Line up the suspension bracket against the top edge of the frame so that the screw holes are closest to the edge. Make sure the suspension bracket is centred equidistant from each side.
- 7) Mount the suspension bracket on Frame using the short screws provided. Important! All six screws must be used.
- 8) On Frame's lower edge, mount the included adjustable feet at the opposite end of the installed suspension bracket.
- 9) Hold Frame up against the wall and mark the top edge of Frame with a pencil on the wall at the height at which Frame will be mounted.
- 10) To mount Frame accurately, measure 7 cm down from the top edge where you will draw a line that must be level. This line is now the same height as the suspension bracket that Frame will hang on.
- 11) On the chosen wall mark the holes on the suspension bracket. Remember to turn the suspension bracket properly with the holes at the bottom and hanging edge at the top. The included wall plugs and screws can be used, if Frame is to be mounted on a concrete or brick wall. In this case follow steps 12 and 13.
- 12) Drill holes using a 6 mm masonry drill bit.
- 13) Lock included wall plugs into the drilled holes.
- 14) Mount the suspension bracket using the long screws.
- 15) Use all 6 holes.
- 16) Now you can hang Frame on the wall. If the wall is slanted, screw in the adjustable feet until Frame hangs level.
- 17) With the correct mounting, Frame will now "float" about 6 mm from the wall. If you wish to mount additional Frame modules close to each other, repeat steps 1-17. In step 10, please measure 7.2 mm from the lower edge of the Frame already mounted.



instructions

shelf for frame

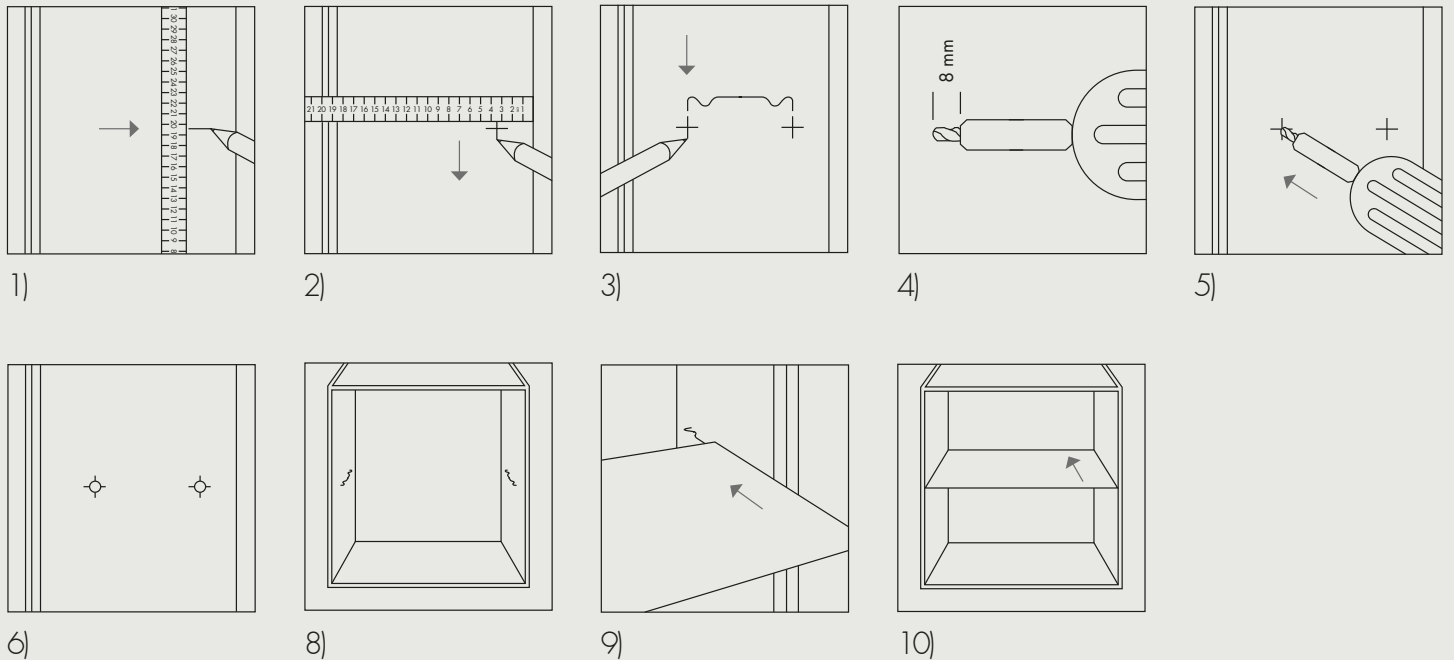

Tool list: tape measure, drill, drill bit with depth limiter, pencil and small spirit level.

- 1) Define whether the shelf is to be mounted vertically or horizontally as well as the desired distance from the base/side. Shelf height is determined by measuring from the base or side of Frame. If the shelf is to be mounted at centre, place a mark 19.7 cm (Frame 42) or 23.1 cm (Frame 49) from the base/side. If the shelf is not to be mounted at centre, ensure that the upper edge of the shelf is placed 0.5 cm above the mark.
- 2) Measure 3.5 cm from the back of Frame, where a cross is added at the desired shelf height.
- 3) The wire shelf support is used to determine the distance from the first marked cross. Use the tape measure and a small spirit level.
- 4) Use the included drill bit with depth limited so that the limiter is positioned fully against the drill chuck. Make sure that the tip of the drill bit is at a depth of max. 8 mm without the limiter, otherwise the drill can perforate through the other side of the box. Please note that a perforated box cannot be returned or exchanged.
- 5) Drill in the centre of the crosses using the drill with limiter.
- 6) The holes are drilled.
- 7) Repeat steps 1-6 on the other side of Frame.
- 8) Insert the wire shelf support on both sides.
- 9) Push the shelf in over the wire shelf support in the shelf slots.
- 10) Push the shelf in completely.